

## Specifications TEG Module TEG1-1263-4.3

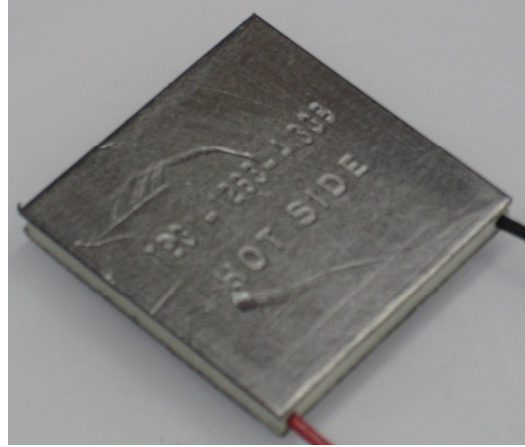

### SNAPSHOT SPECIFICATION FOR TEG1-1263-4.3

Hot Side Temperature (°C)	300
Cold Side Temperature (°C)	30
Open Circuit Voltage (V)	10.7
Matched Load Resistance (ohms)	5.4
Matched load output voltage (V)	5.3
Matched load output current (A)	1.0
Matched load output power (W)	5.2
Heat flow across the module(W)	≈ 115
Heat flow density(Wcm <sup>-2</sup> )	≈ 13
AC Resistance(ohms) Measured under 27°C at 1000Hz	2.7~3.6

### Geometric Characteristics Dimensions in millimeter

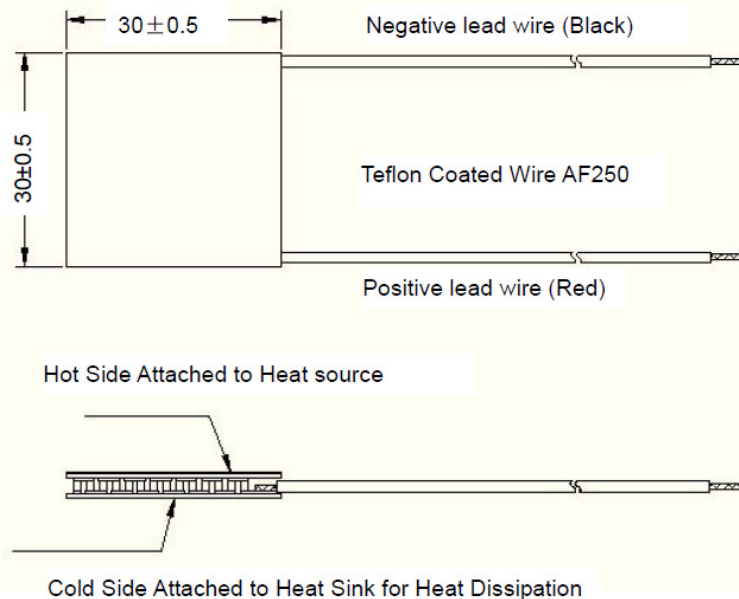

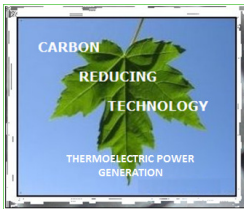

**SNAPSHOT SPECIFICATION FOR TEG1-1263-4.3**

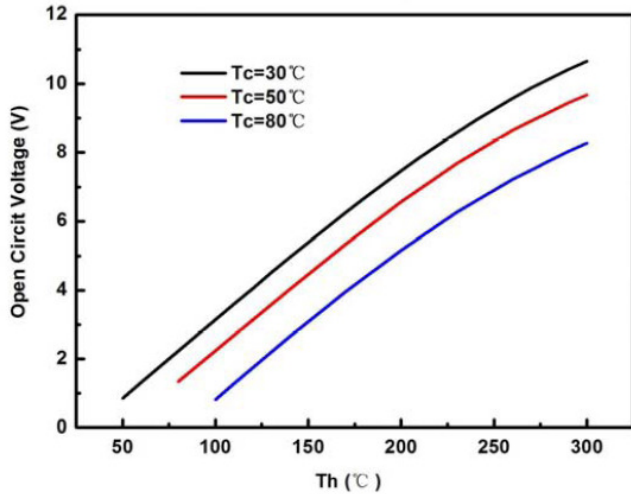

The chart for open circuit voltage Vs  $T_h$  under various  $T_c$

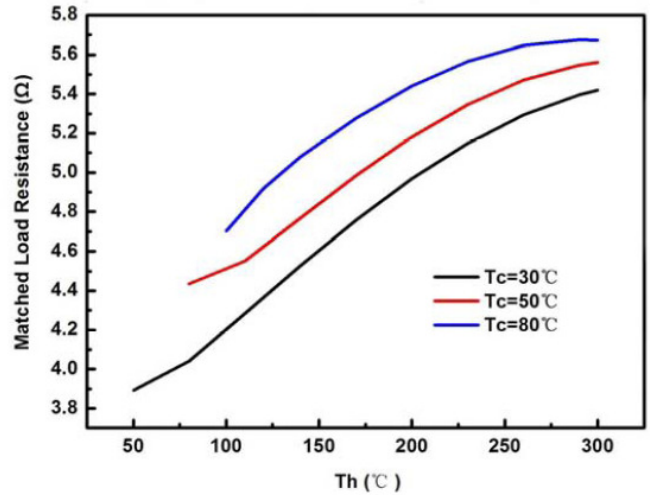

The chart for matched load resistance Vs  $T_h$  under various  $T_c$

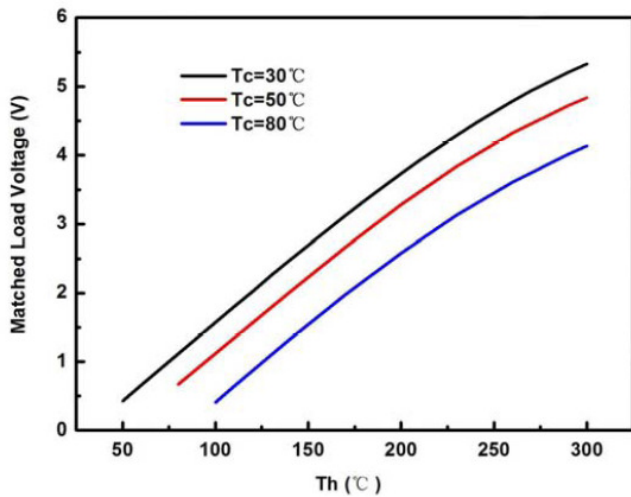

The chart for matched load voltage Vs  $T_h$  under various  $T_c$

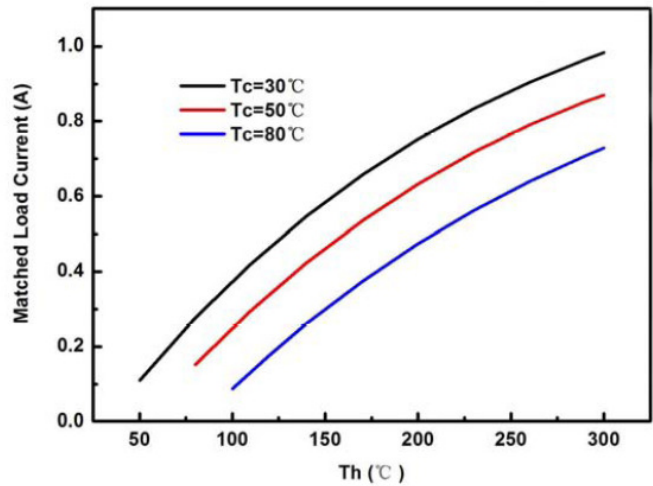

The chart for matched load current Vs  $T_h$  under various  $T_c$

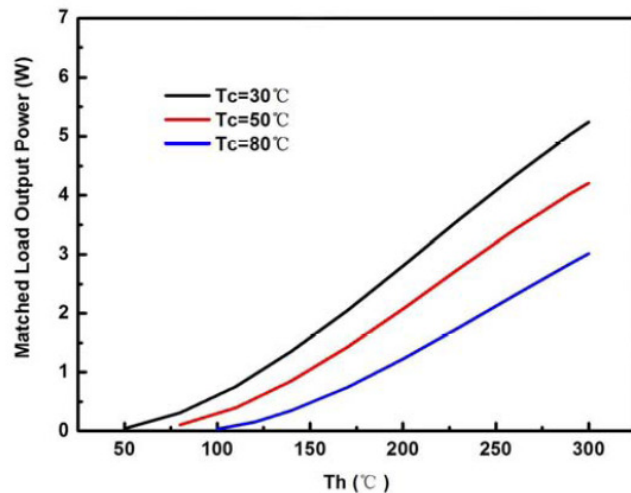

The chart for matched load voltage Vs  $T_h$  under various  $T_c$

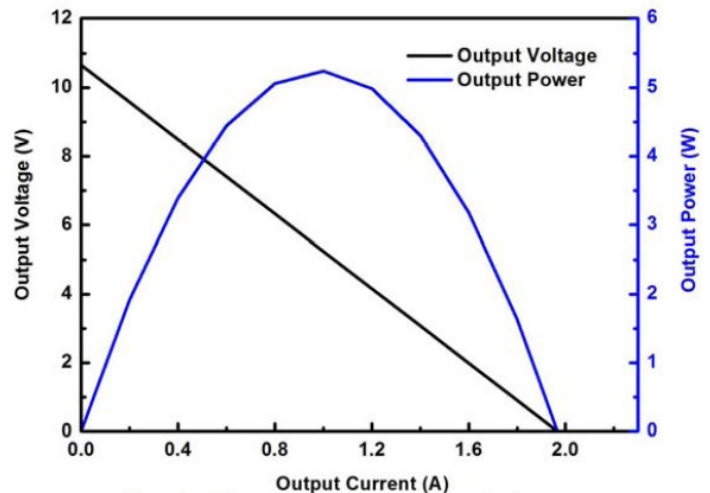

The chart for output voltage and output power Vs output current under  $T_h=300^\circ\text{C}$  and  $T_c=30^\circ\text{C}$